

$$I_{F(AV)} = 19\text{Amp}$$

$$V_R = 15\text{V}$$

**Major Ratings and Characteristics**

Characteristics	Values	Units
$I_{F(AV)}$ Rectangular waveform	19	A
$V_{RRM}$	15	V
$I_{FSM}$ @tp = 5 $\mu$ s sine	700	A
$V_F$ @19 Apk, $T_J = 75^\circ\text{C}$	0.32	V
$T_J$ range	-55 to 125	$^\circ\text{C}$

**Description/ Features**

The 19TQ015PbF Schottky rectifier has been optimized for ultra low forward voltage drop specifically for the OR-ing of parallel power supplies. The proprietary barrier technology allows for reliable operation up to 125 $^\circ\text{C}$  junction temperature. Typical applications are in parallel switching power supplies, converters, reverse battery protection, and redundant power subsystems.

125 $^\circ\text{C}$   $T_J$  operation ( $V_R < 5\text{V}$ )

- Optimized for OR-ing applications
- Ultra low forward voltage drop
- High frequency operation

Guard ring for enhanced ruggedness and long term reliability

- High purity, high temperature epoxy encapsulation for enhanced mechanical strength and moisture resistance

Lead-Free ("PbF" suffix)

**Case Styles**

19TQ015PbF



TO-220AC

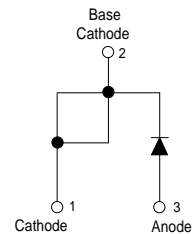

## Voltage Ratings

Part number	19TQ015PbF
$V_R$ Max. DC Reverse Voltage (V)	15
$V_{RWM}$ Max. Working Peak Reverse Voltage (V)	

## Absolute Maximum Ratings

Parameters	19TQ	Units	Conditions
$I_{F(AV)}$ Max. Average Forward Current * See Fig. 5	19	A	50% duty cycle @ $T_C = 80^\circ\text{C}$ , rectangular wave form
$I_{FSM}$ Max. Peak One Cycle Non-Repetitive Surge Current * See Fig. 7	700	A	Following any rated load condition and with rated $V_{RRM}$ applied
	330		
$E_{AS}$ Non-Repetitive Avalanche Energy	6.75	mJ	$T_J = 25^\circ\text{C}$ , $I_{AS} = 1.50$ Amps, $L = 6$ mH
$I_{AR}$ Repetitive Avalanche Current	1.50	A	Current decaying linearly to zero in 1 $\mu\text{sec}$ Frequency limited by $T_J$ max. $V_A = 3 \times V_R$ typical

## Electrical Specifications

Parameters	19TQ	Units	Conditions
$V_{FM}$ Max. Forward Voltage Drop (1) * See Fig. 1	0.36	V	@ 19A $T_J = 25^\circ\text{C}$
	0.46	V	@ 38A $T_J = 25^\circ\text{C}$
	0.32	V	@ 19A $T_J = 75^\circ\text{C}$
	0.43	V	@ 38A $T_J = 75^\circ\text{C}$
$I_{RM}$ Max. Reverse Leakage Current (1) * See Fig. 2	10.5	mA	$T_J = 25^\circ\text{C}$ $V_R = \text{rated } V_R$
	522	mA	$T_J = 100^\circ\text{C}$ $V_R = \text{rated } V_R$
	465	mA	$T_J = 100^\circ\text{C}$ , $V_R = 12\text{V}$
	285	mA	$T_J = 100^\circ\text{C}$ , $V_R = 5\text{V}$
$C_T$ Max. Junction Capacitance	2000	pF	$V_R = 5V_{DC}$ (test signal range 100Khz to 1Mhz) $25^\circ\text{C}$
$L_S$ Typical Series Inductance	8.0	nH	Measured lead to lead 5mm from package body
dv/dt Max. Voltage Rate of Change (Rated $V_R$ )	10000	V/ $\mu\text{s}$	

(1) Pulse Width < 300 $\mu\text{s}$ , Duty Cycle < 2%

## Thermal-Mechanical Specifications

Parameters	19TQ	Units	Conditions
$T_J$ Max. Junction Temperature Range	-55 to 125	$^\circ\text{C}$	
$T_{stg}$ Max. Storage Temperature Range	-55 to 150	$^\circ\text{C}$	
$R_{thJC}$ Max. Thermal Resistance Junction to Case	1.50	$^\circ\text{C}/\text{W}$	DC operation * See Fig. 4
$R_{thCS}$ Typical Thermal Resistance, Case to Heatsink	0.50	$^\circ\text{C}/\text{W}$	Mounting surface, smooth and greased
wt Approximate Weight	2 (0.07)		g (oz.)
T Mounting Torque	Min.	6 (5)	Kg-cm (lbf-in)
	Max.	12 (10)	
Marking Device	19TQ015		

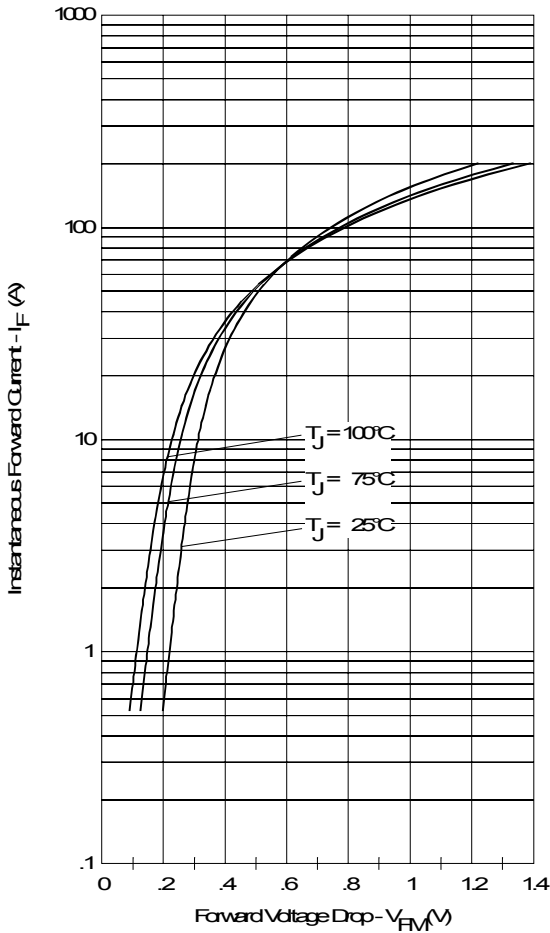

Fig. 1 - Maximum Forward Voltage Drop Characteristics

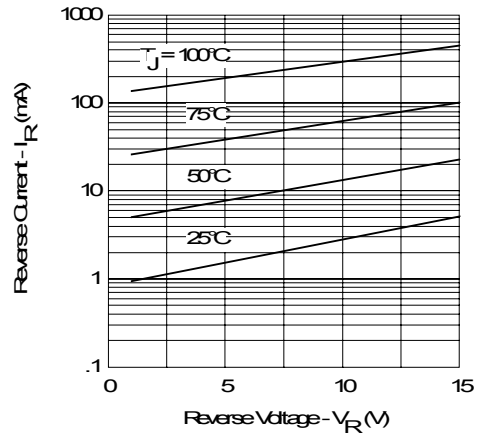

Fig. 2 - Typical Values of Reverse Current Vs. Reverse Voltage

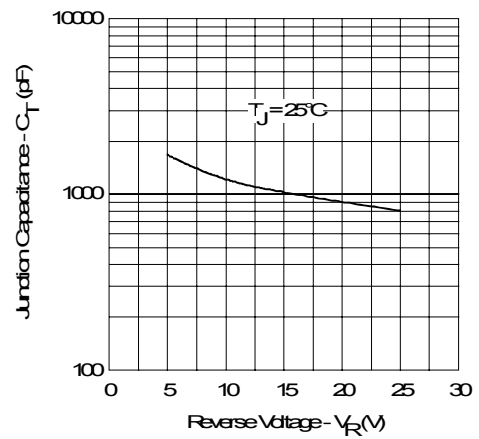

Fig. 3 - Typical Junction Capacitance Vs. Reverse Voltage

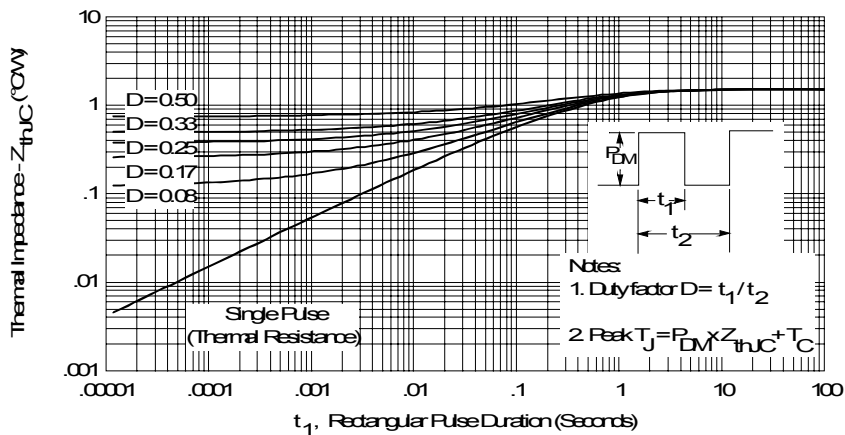

Fig. 4 - Maximum Thermal Impedance  $Z_{thJC}$  Characteristics

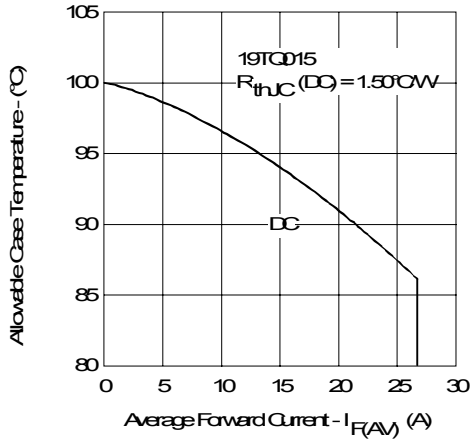

Fig. 5 - Maximum Allowable Case Temperature Vs. Average Forward Current

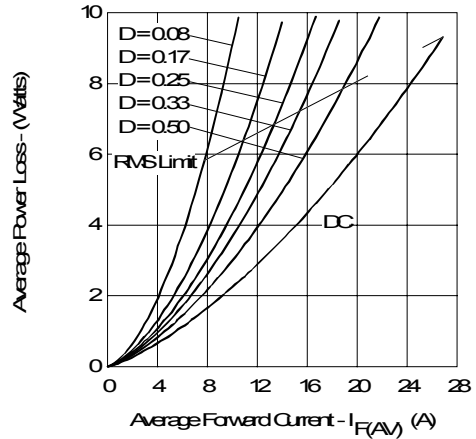

Fig. 6 - Forward Power Loss Characteristics

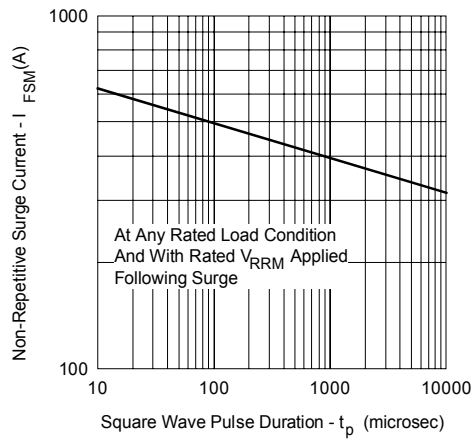

Fig. 7 - Maximum Non-Repetitive Surge Current

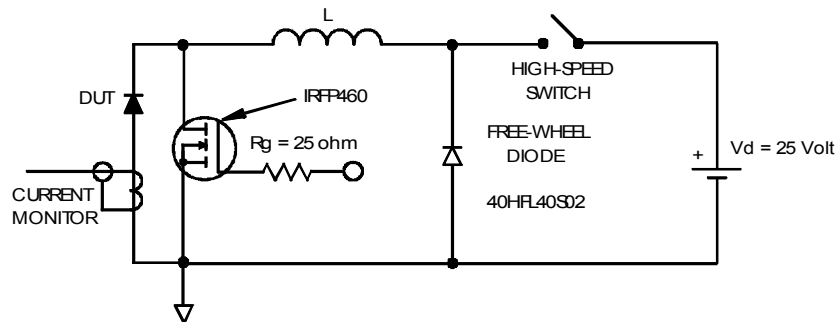
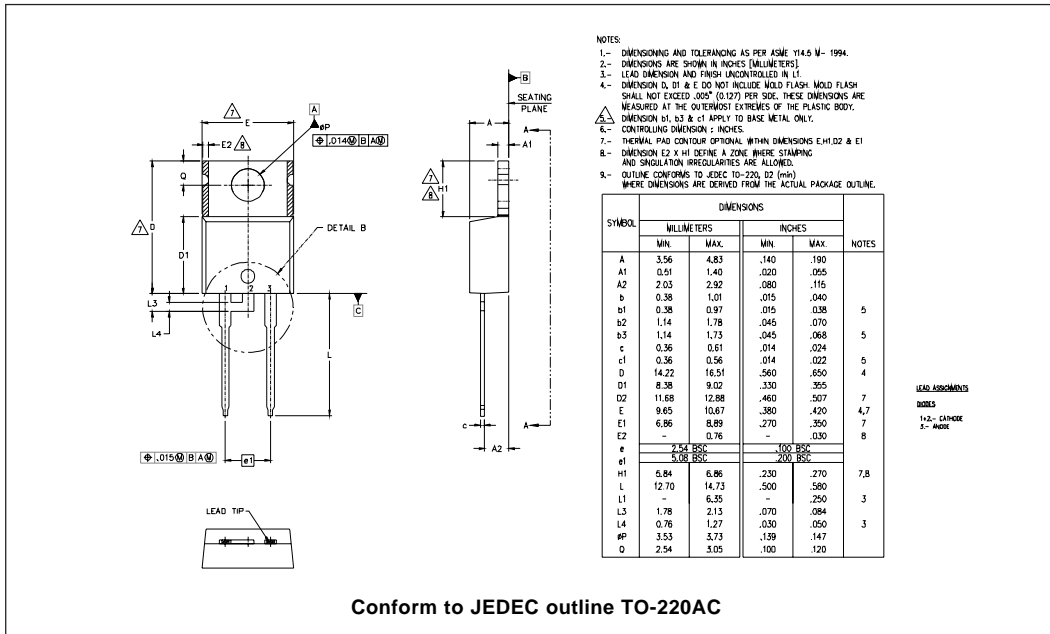
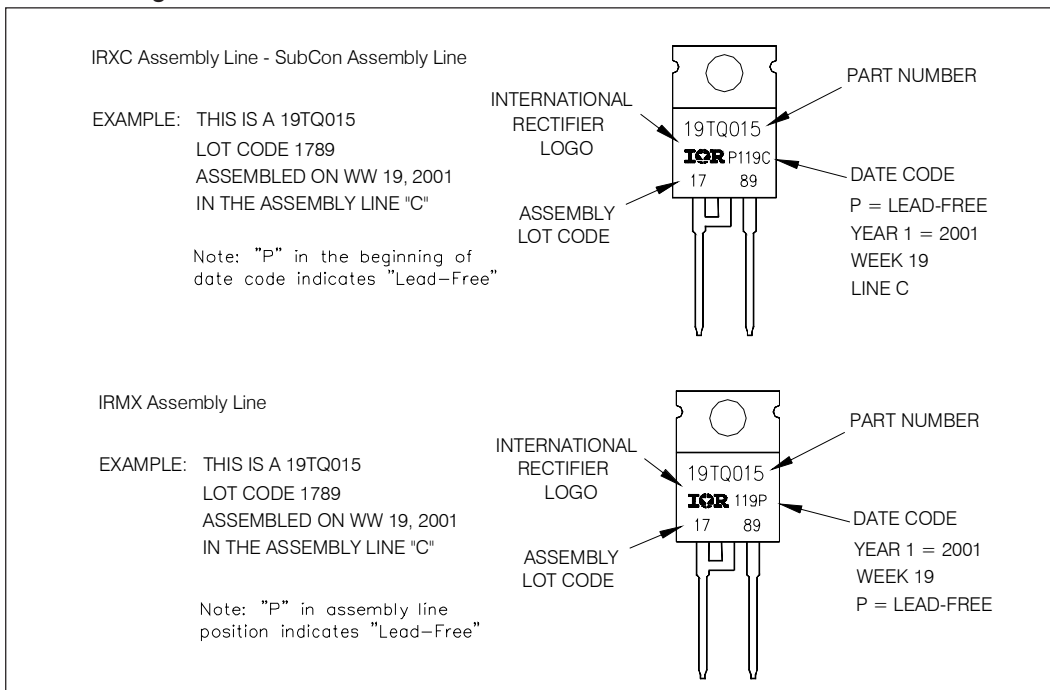

Fig. 8 - Unclamped Inductive Test Circuit

Outline Table



Part Marking Information



Ordering Information Table

Device Code											
	<table border="1" style="margin: auto;"> <tr> <td style="padding: 5px;">19</td> <td style="padding: 5px;">T</td> <td style="padding: 5px;">Q</td> <td style="padding: 5px;">015</td> <td style="padding: 5px;">PbF</td> </tr> <tr> <td style="text-align: center;">①</td> <td style="text-align: center;">②</td> <td style="text-align: center;">③</td> <td style="text-align: center;">④</td> <td style="text-align: center;">⑤</td> </tr> </table>	19	T	Q	015	PbF	①	②	③	④	⑤
19	T	Q	015	PbF							
①	②	③	④	⑤							
<b>1</b>	- Current Rating (19 = 19A)										
<b>2</b>	- Package T = TO-220										
<b>3</b>	- Schottky "Q" Series										
<b>4</b>	- Voltage Rating (015 = 15V)										
<b>5</b>	- <ul style="list-style-type: none"> <li>• none = Standard Production</li> <li>• PbF = Lead-Free</li> </ul>										
Tube Standard Pack Quantity : 50 pieces											

Data and specifications subject to change without notice.  
 This product has been designed and qualified for Industrial Level and Lead-Free.  
 Qualification Standards can be found on IR's Web site.